

Impacta Ltd

*Pallet Furniture, Industrial Supplies,
Consumables & Accessories*

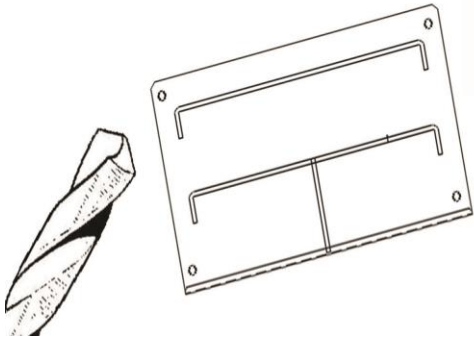
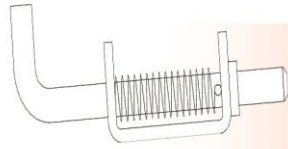
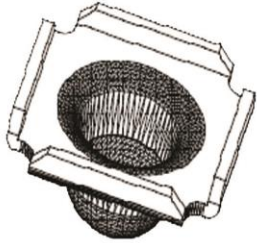

Impacta Ltd

Pallet Furniture, Consumables
& Accessories

Pallet Furniture, Industrial Supplies, Consumables & Accessories

Sales@impacta.co.uk

01902 496 307

Pallet Feet

Palletfeet.co.uk

IMP-4 PALLET FOOT

Manufactured from mild steel, suitable for containers and stillages.

Suitable for	40 x 40 box section
Material	3mm mild steel
Surface Treatment	Anti-rust
Weight	59g

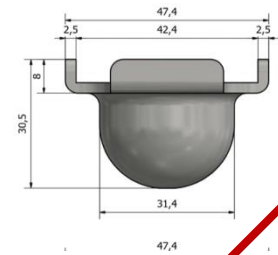

IMP-5 PALLET FOOT

Manufactured from mild steel, suitable for containers and stillages.

Suitable for	50 x 50 box section
Material	3mm mild steel
Surface Treatment	Anti-rust
Weight	118g

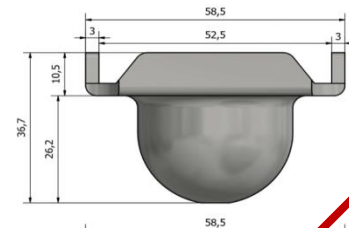

IMP-6 PALLET FOOT

Manufactured from mild steel, suitable for containers and stillages.

Suitable for	60 x 60 box section
Material	3mm mild steel
Surface Treatment	Anti-rust
Weight	169g

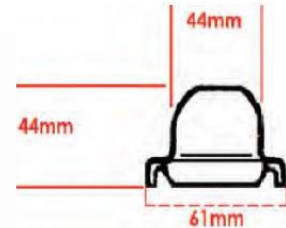

IMP-JLR PALLET FOOT

An off-set foot used on Jaguar Land Rover containers. Complete with chamfered corner and must be positioned on the outer corner

Suitable for	60 x 60 box section
Material	3mm mild steel
Surface Treatment	Anti-rust
Weight	142g

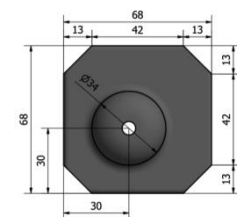

IMP-SQ 40 X 50 PALLET

Manufacture from mild steel, suitable for containers and stillages with 40 x 40 and 50 x 50 box section.

Suitable for	40x40 & 50x50 box section
Material	3mm mild steel
Surface Treatment	Anti-rust
Weight	142g

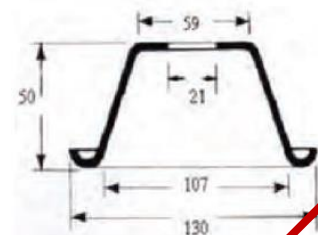

Pallet Feet

Palletfeet.co.uk

IMP-TOP CAP 50

Designed to be affixed to pallets corners to protect against damage. Ready for welding & suitable for angle or box type pallets. Extends life of stillage's by rust and water proofing

Suitable for	50 x 50 box section
Material	5mm mild steel
Surface Treatment	Anti-rust
Weight	55g

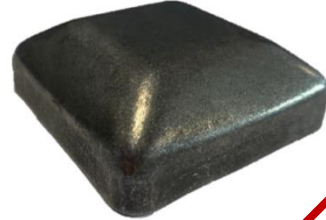

IMP 5 FLANGLESS

Designed to be affixed to pallets corners to protect against damage. Ready for welding & suitable for angle or box type pallets.

Suitable for	50 x 50 box section
Material	5mm mild steel
Surface Treatment	Mild Steel
Weight	118g



IMP ELEPHANT 40

Designed to be affixed to pallets as stillage feet. Ready for welding and suitable for angle or box type pallets

Suitable for	40 x 40 / 30 x 30 box section
Material	2.5mm mild steel
Surface Treatment	Anti-rust
Weight	

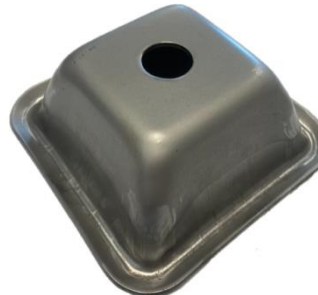

IMP QUARTER 40*50

Protective corner for a range of stillage's and pallets

Suitable for	
Material	5mm mild steel
Surface Treatment	Anti-rust
Weight	381g



IMP TC 50

Designed to be affixed to pallets corners to protect against damage. Ready for welding & suitable for angle or box type pallets.

Suitable for	50mm
Material	4mm mild steel
Surface Treatment	Anti-rust
Weight	



Bolts & Catches

IMP-P BOLT

- Spring loaded pull bolt
- Pull cords available

Suitable for	Locking Applications
Material	Mild steel
Quantity	Minimum Order of 10
Weight	-

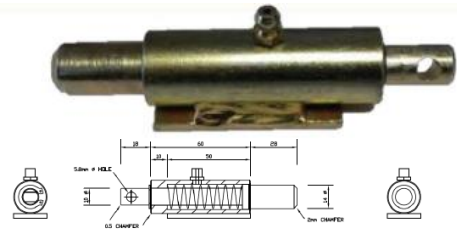

IMP-G BOLT

- Pull, twist and lock action
- Finger pull locking shoot bolt

Suitable for	Locking Applications
Material	Mild steel
Quantity	Minimum Order of 10
Weight	-

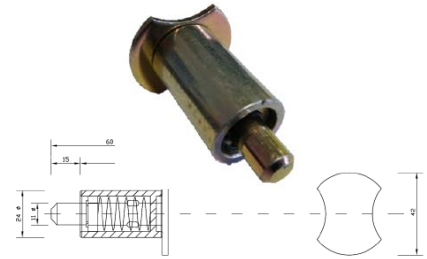

IMP-L BOLT

- Non locking spring bolt

Suitable for	Locking Applications
Material	Mild steel
Quantity	Minimum Order of 10
Weight	-

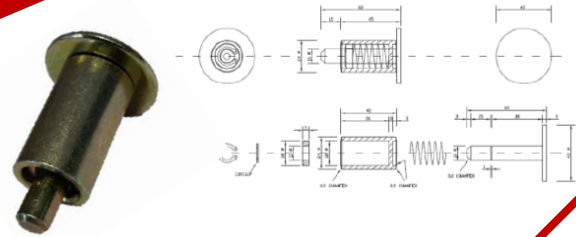

IMP-L/H BOLT

- Non locking spring bolt
- Finger pull locking shoot bolt, 5mm thick wire

Suitable for	Locking Applications
Material	Mild steel
Quantity	Minimum Order of 10
Weight	-

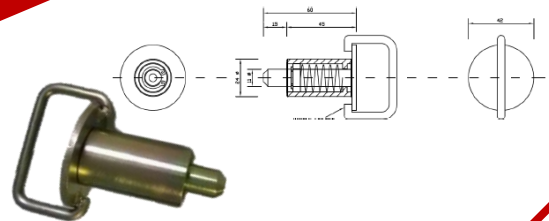

IMP-G/H BOLT

- Lockable "pull, twist, lock" Spring bolt
- Finger pull locking shoot bolt, 5mm thick wire

Suitable for	Locking Applications
Material	Mild steel
Quantity	Minimum Order of 10
Weight	-

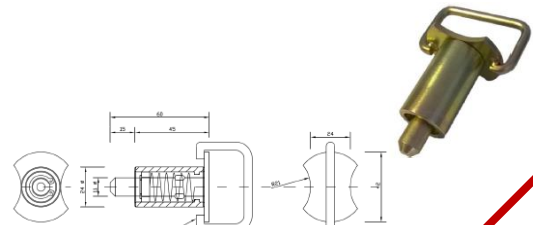

IMP-SSB

- Zinc plated
- Narrow base for an easy weld

Suitable for	Locking Applications
Material	Zinc plated steel
Quantity	Minimum Order of 10



Accessories

Palletfeet.co.uk

IMP – L bolt with ring

Suitable for	Locking Applications
Material	Mild steel
Quantity	Minimum Order of 10
Weight	-



IMP-72 catch locator

Steel pressed catch to be used in conjunction with our IMP P, G and L plunge bolts

Suitable for	See above
Material	2mm mild steel
Surface Treatment	Anti-rust
Weight	-



IMP-Elastic rope

10mm thick elastic bungee shock cord with black nylon thread.

Suitable for	Range of uses
Material	Elastic/Nylon
Surface Treatment	-
Total Length	Cut to order



IMP -Hook and Loop

- Self-Adhesive hook and loop Velcro
- Colour: Black

Suitable for	Fixing Applications
Material	Velcro
Widths available	25mm, 50mm, 100mm
Length	25 metres



IMP- Fluorescent Hook + Loop

- Self-Adhesive hook and loop Velcro
- Colour: Fluorescent

Suitable for	Fixing Applications
Material	Velcro
Widths available	25mm, 50mm, 100mm
Length	25 metres



Accessories

Palletfeet.co.uk

IMP- SC200D

Sleeve Collar

An alternative installation when major disassembly would normally be required.

Suitable for	Hard and soft shafts
Material	Steel
Surface treatment	Zinc Plated
Quantity	50pcs/carton



IMP- Stencil Spray paint

Colours available: White, Black or Metallic Silver spray paint

Suitable for	Touch ups. Stencilling
Volume	400ml
Quantity	12 per pack



IMP- LFR

Long Flange Rivet

Size: 4.8 x 20mm with a 14mm large flange head
The grip range is between 3.0 -6.0

Suitable for	Joining metal plate
Material	Aluminium and steel
Surface treatment	-
Quantity	250pcs/carton



IMP- Nameplate

Heavy duty plastic nameplate with brushed aluminium effect finish. Personalised to your specification.

Suitable for	Identification
Material	Heavy duty plastic
Size	40mm x 110mm
Quantity	-



IMP- Polyprop wearboard

Highly durable polypropylene board, resistant to damage, chemicals and temperature fluctuations

Suitable for	Range of uses
Material	Polypropylene
Size	Cut to your specifications
Weight	-



Accessories

IMP - SDS

Self-Drilling Screws

Size: 5.5 x 22mm

Suitable for	Fastening
Material	C1022 Steel
Surface Treatment	Zinc Plated
Quantity	500pcs/carton



IMP – HSS Drill bits

- HSS (High Speed Steel)
- Double Ended
- M2 Material

Suitable for	Wood/Metal
Material	M2 Steel
Sizes available	5mm, 6mm, 7mm, 8mm
Pack Quantity	10



IMP – Protective End Caps

Standard colours are black, blue, red and yellow but other colours of vinyl caps can be made to order.

Suitable for	End Protection
Material	Vinyl
Width	2.8 – 5.6mm
Length	6 – 32mm



End Caps

New range of end caps. Suitable for 25mm, 40mm and 50mm box section. These will add the finishing touch to any project!

Suitable for	Stillages, pallets etc.
Material	Heavy duty plastic
Size	various
Quantity	-



Plastic Eyelets

Suitable for plastic sheeting, tarps, canvas and heavy cloth sheeting.

Suitable for	See above
Material	PP
Size	26mm Diameter
Quantity	-



Document Holders

Palletfeet.co.uk

IMP – Doc clip

A spring steel pressed clip suitable for holding documents in place on plastic boxes. Long wearing, sustainable and reusable – as opposed to using PVC pockets.



Suitable for	Box thickness: 2 – 2.5mm
Material	Spring Steel
Surface treatment	Bright zinc plated
packaged	100pcs per box



IMP – A5 card holder

Manufactured from mild steel. Pre-punched holes in each corner for rivet attachment.

Suitable for	Document display
Material	Mild steel
Surface treatment	Bright zinc plated
Weight	270.5g
Packaged	25pcs per carton

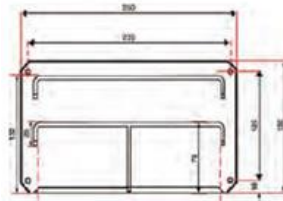

IMP – GM wire hanger

Suitable for	Lineside document display
Material	4mm steel wire
Surface treatment	Zinc plated
Packaged	100pcs per box

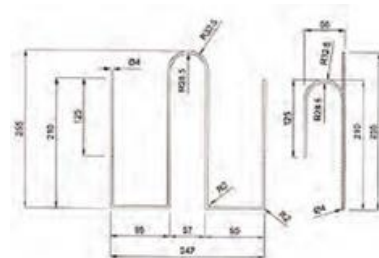

IMP – Brush Bar

Providing protection against clash damage.
Available in various sizes.

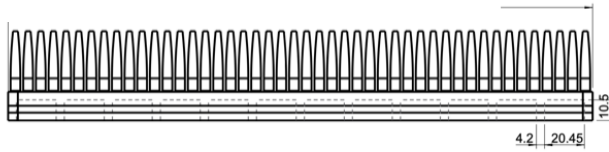

IMP- Galvanised chain

3mm galvanised static release chain with bright zinc plated finish. Can be used in textile curtains.
Link length 21mm by 11.5mm width

Suitable for	Textile Curtains
Material	3mm galvanised steel
Surface Treatment	Zinc plated
Total Length	30 metre reel

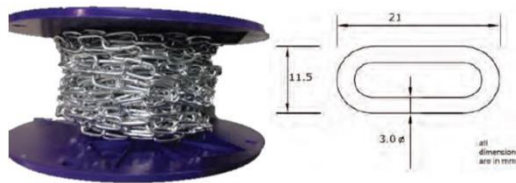

IMP – Gas Struts

Gas struts now available in various sizes with optional printing

Piston rod – chromium plated with cylinder black spray coating

Specific requirements on request
Swift lead times

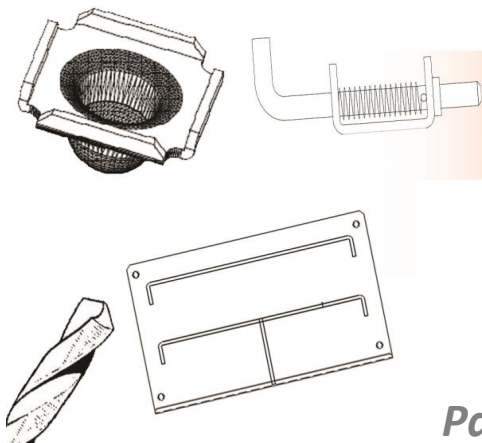

Impacta Ltd

*Pallet Furniture, Industrial
Supplies, Consumables &
Accessories*